

# Clear Duo Deep Fryer

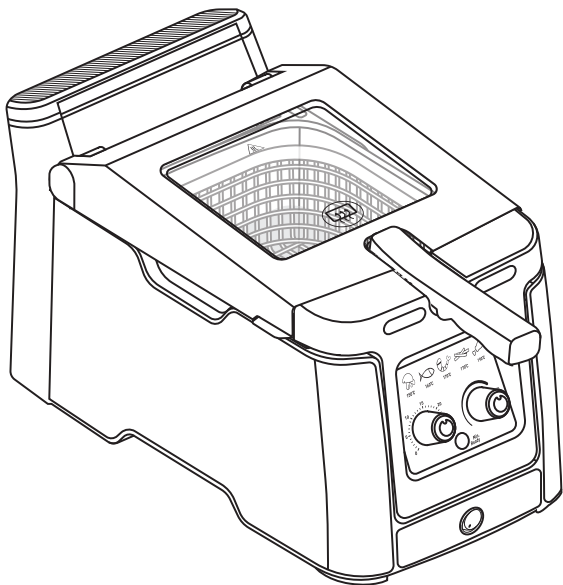

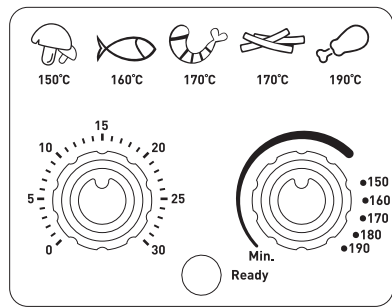

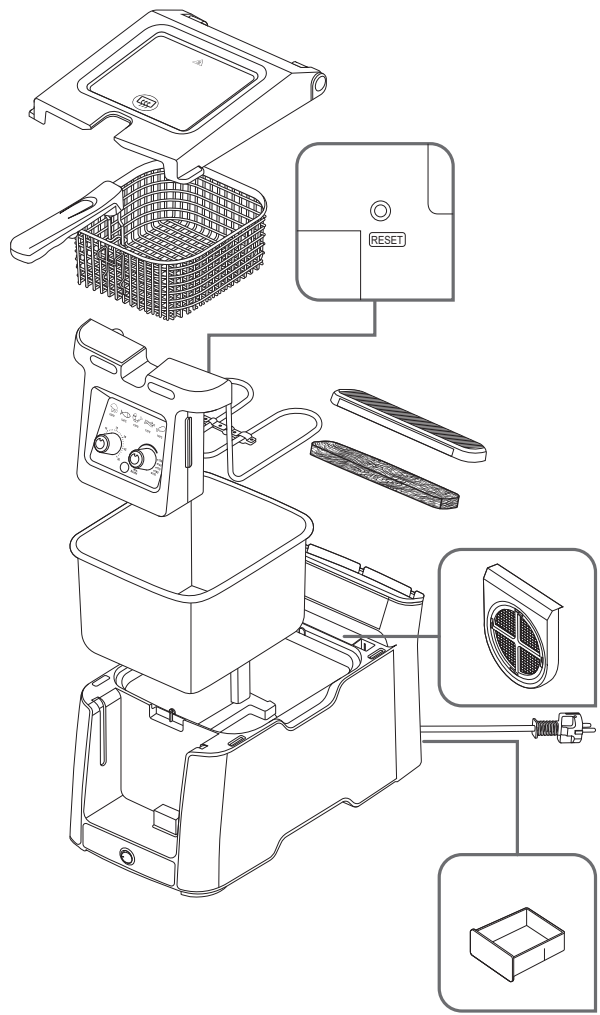
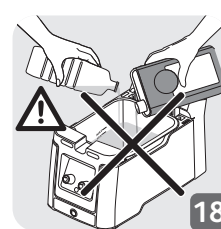
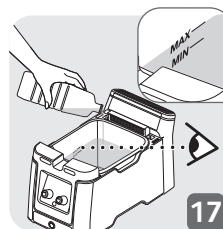
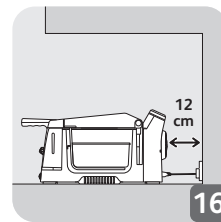
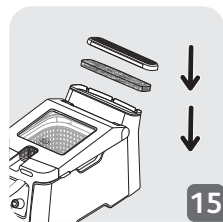
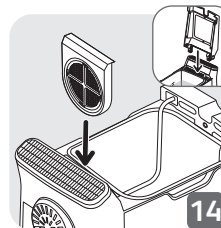
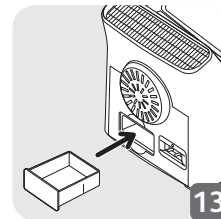
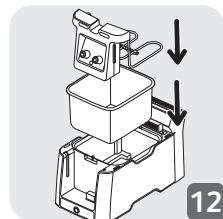
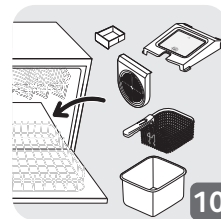
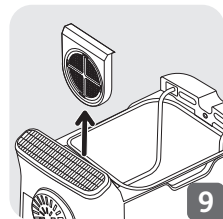
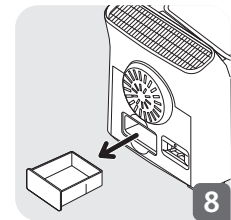
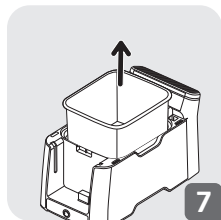
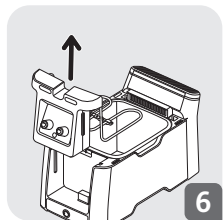
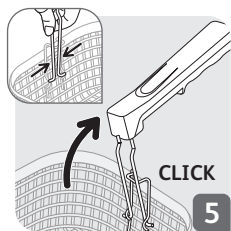
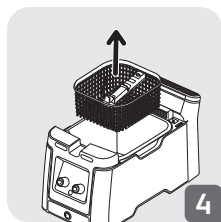
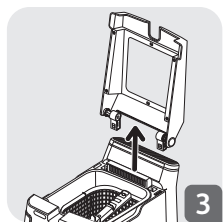
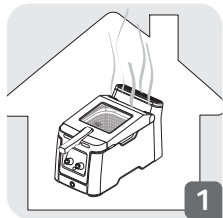

4

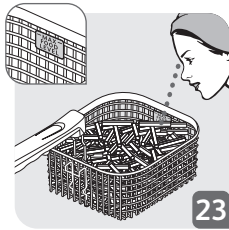
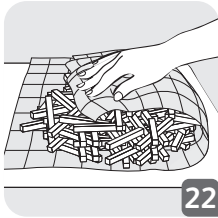
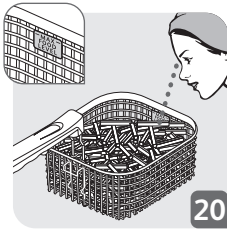

5

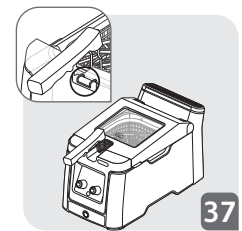
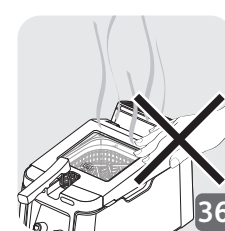
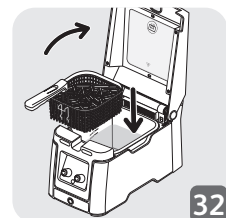
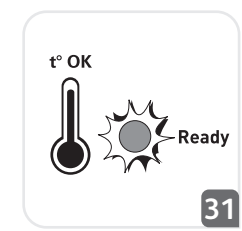
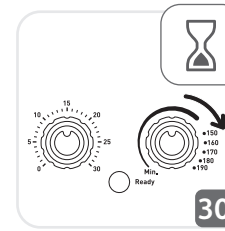
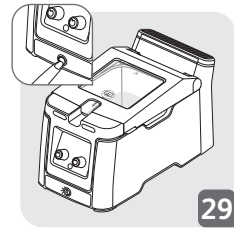

6



	Nb		°C	
		350g	170°C	6-8 min
		400g	160°C	6-8 min
	8-9		170°C	5-6 min
		400g	150°C	10-12 min
			°C	
		650g	170°C	9-11 min
	12		190°C	6-7 min
		500g	190°C	4-6 min
	10-12		190°C	6-8 min

7

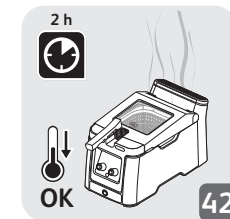
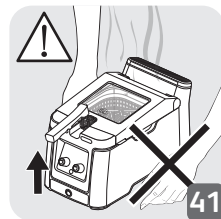
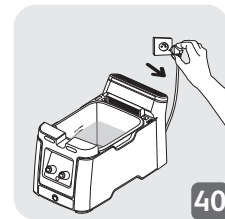
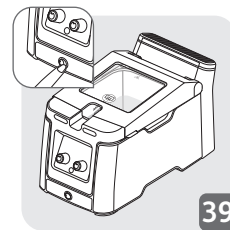
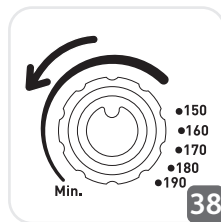

8

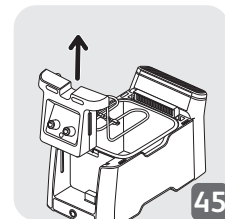
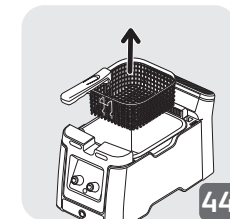
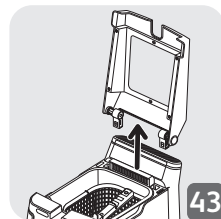

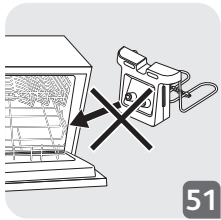
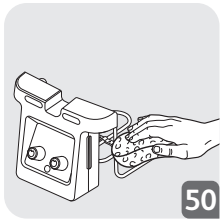
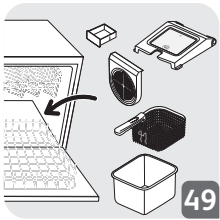
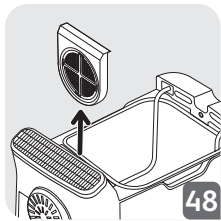
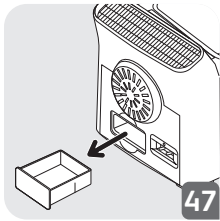
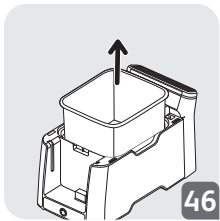

9 

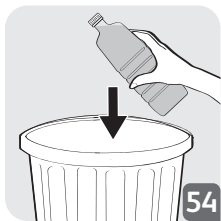
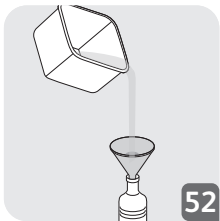

10 

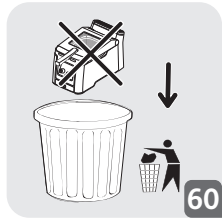
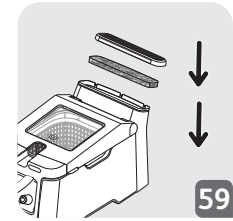
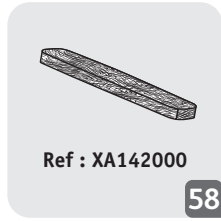
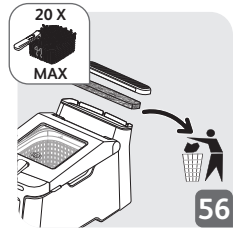
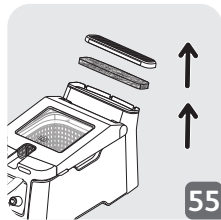

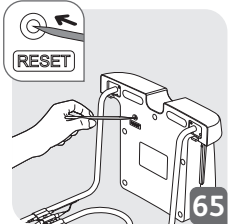
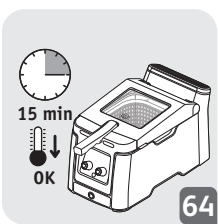
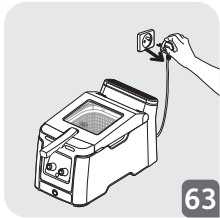

1820010732